

MASTERVOLT

THE POWER TO BE INDEPENDENT

EasyView 5

MONITORING AND CONTROL PANEL
FOR THE MASTERBUS NETWORK

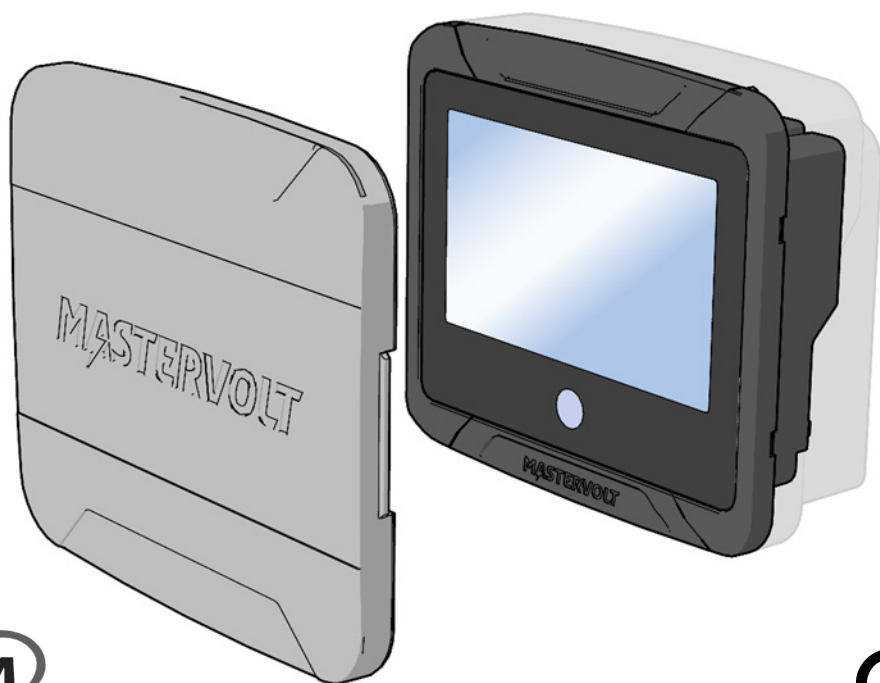

- (NL) Ga om deze handleiding in andere talen te downloaden naar onze website:
(DE) Um diese Anleitung in anderen Sprachen herunterzuladen, besuchen Sie bitte unsere Website:
(FR) Pour télécharger ce manuel dans d'autres langues, consultez notre site Web :
(ES) Para descargar este manual en otros idiomas, visite nuestro sitio web:
(IT) Per scaricare questo manuale in altre lingue, visitare la pagina del prodotto sul nostro sito Web:

www.mastervolt.com

10000011559/11

Table of contents

1	Product description	3	5.3	Dashboard and navigation	13
1.1	Parts	3	5.4	Maintenance	13
1.2	Connections	4	6	Monitoring and configuration	14
1.3	Accessories	5	6.1	Favorite pages	14
2	Safety	6	6.1.1	Adding widgets to favorite pages	14
2.1	Safety instructions	6	6.1.2	Widget order / move a widget	16
2.2	Liability	6	6.1.3	Removing a widget	16
2.3	Warranty	6	6.1.4	Renaming a widget	17
2.4	Disclaimer	6	6.2	System page	18
2.5	Correct disposal of this product	6	6.3	Device page	18
2.6	Identification label	6	6.4	Alarms	19
3	MasterBus	7	6.5	EasyView 5 monitoring settings	20
3.1	About MasterBus	7	6.6	EasyView 5 configuration settings	21
3.2	Event based commands	7	6.7	EasyView 5 events	22
3.3	How to set up a MasterBus network	8	6.7.1	Event source	22
4	Installation instructions	9	6.7.2	Event target	22
4.1	Panel mounting	9	6.8	Event data	23
4.2	Clamp mounting	10	6.9	Configuring other devices	23
4.3	Aux power supply	11	6.10	Digital switches	24
4.3.1	Aux power connector	11	6.11	Customize alarm messages	24
4.3.2	Wire size	11	6.12	Customize the startup screen	24
4.3.3	Fuse	11	7	Updates	25
5	Operation	12	8	MasterAdjust software	26
5.1	General	12	9	Trouble shooting	26
5.2	Home Button	12	10	Specifications	29
5.2.1	Switching on, off or standby	12	10.1	Technical specifications	29
5.2.2	Locking	12	10.2	Dimensions	29
5.2.3	Home	12			

1 Product description

The Mastervolt EasyView 5 is a 4.3" touch display that allows the user to monitor, configure and operate all connected devices in a MasterBus network.

1.1 Parts

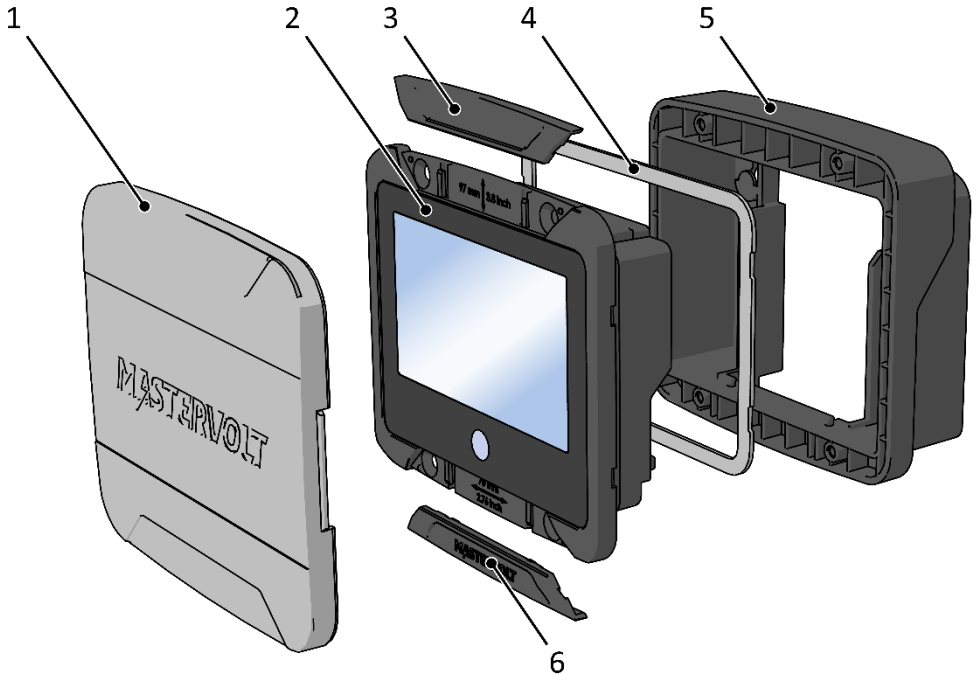

Parts

- | | |
|---|---------------|
| 1 | Front cover* |
| 2 | Display panel |
| 3 | Top cover |
| 4 | Seal** |
| 5 | Wall box |
| 6 | Bottom cover |

* Always use the front cover when the EasyView 5 display needs to be protected from damage or sunlight.

** Always use the seal when the EasyView 5 display needs to be protected from water, moist and dust.

1.2 Connections

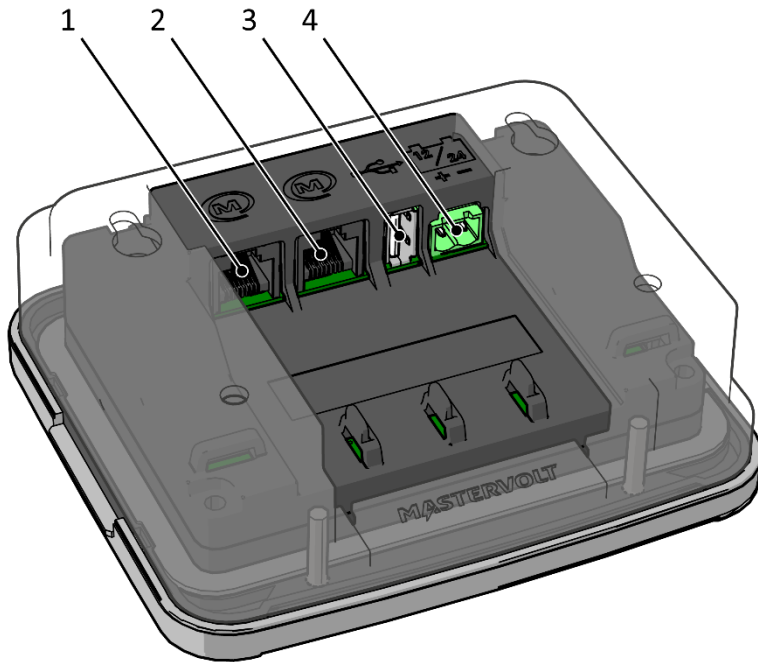

Connections

- | | |
|---|---------------------|
| 1 | MasterBus port 1 |
| 2 | MasterBus port 2 |
| 3 | USB device port |
| 4 | Power input 12/24 V |

1.3 Accessories

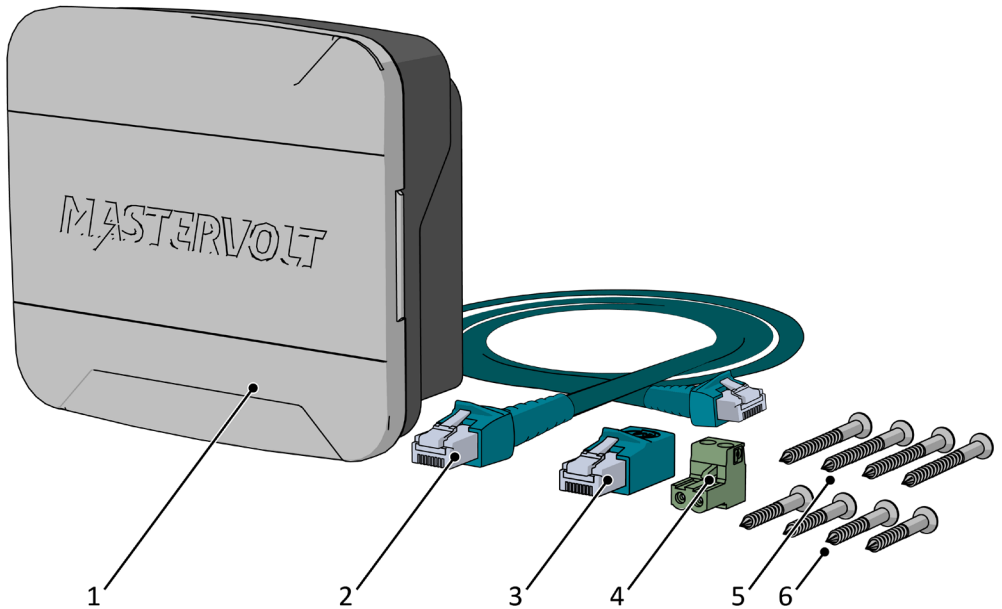

Accessories

- | | |
|---|-----------------------------------|
| 1 | Mastervolt EasyView 5 |
| 2 | MasterBus cable (6 meter / 20ft) |
| 3 | MasterBus terminator |
| 4 | 12/24 V connector |
| 5 | Mounting screw (4 pcs) 4x30mm PH2 |
| 6 | Mounting screw (4 pcs) 4x14mm PH2 |

2 Safety

2.1 Safety instructions



WARNING!

Read the safety instructions before connecting and using the EasyView 5.

- Use the EasyView 5 following the instructions and specifications stated in this manual.
- Only use the EasyView 5 in a technical correct condition.
- Do not connect the EasyView 5 to any other network than the MasterBus network.
- Do not work on an electrical system if it is still connected to a current source. Only allow changes in your electrical system to be carried out by qualified electricians.

2.2 Liability

Mastervolt can accept no liability for:

- Consequential damage resulting from the use of the EasyView 5.
- Possible errors in the included manual and the consequences of these.
- Use that is inconsistent with the purpose of the product.

2.3 Warranty

Mastervolt assures a two-year warranty on the EasyView 5 after purchase, on the condition that the product is installed and used according to the instructions in this manual.

Installation or use not according to these instructions may result in under performance, damage or failure of the product and may void this warranty. The warranty is limited to the cost of repair and/or replacement of the product. Costs for labor or shipping are not covered by this warranty.

2.4 Disclaimer

Our products are subject to continual development and improvement. Therefore, additions or modifications to the products may cause changes to the technical data and functional specifications. No rights can be derived from this document. Please consult our most current Terms & Conditions of Sale.

2.5 Correct disposal of this product



This product is designed and manufactured with high quality materials and components, which can be recycled and reused. Dispose of according to WEEE. Act according to your local rules and do not dispose of your old products with your normal household waste. The correct disposal of your old product will help prevent potential negative consequences to the environment and human health.

2.6 Identification label

The identification label is located at the back side of the EasyView 5. Important information required for service and maintenance can be derived from the identification label.



Figure 1: Identification label



Never remove the identification label! Warranty void when label is removed!

3 MasterBus

3.1 About MasterBus



All devices that are compatible with MasterBus are marked with the MasterBus symbol. MasterBus is a CAN based, fully decentralized data network for communication between Mastervolt devices. MasterBus is used as power management system for all connected equipment, such as the inverter, battery charger, generator and many more.

Every device that is compatible with MasterBus is equipped with two data ports. The devices are simply chained together, forming a local data network. Monitoring panels such as the EasyView 5 can be used for monitoring and control of all connected MasterBus equipment.



CAUTION:

Never connect a non-MasterBus device to the MasterBus network directly! This will void warranty of all MasterBus devices connected.

3.2 Event based commands

With MasterBus a device can be programmed to initiate an action at another connected device. This is done by means of *event-based commands*. See section 6.7 on page 22.

3.3 How to set up a MasterBus network

Connections between the devices are made by standard straight MasterBus cables. Mastervolt can supply these cables.



Up to 63 MasterBus devices can be connected together.

The electric power for the network comes from the connected devices.

At least one device in the network should have powering capabilities (see specifications).

The EasyView 5 has powering capabilities if the auxiliary supply is connected to the battery.

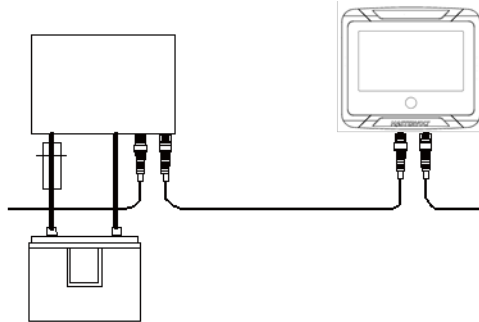

MasterBus needs a terminating device on both ends of the network.

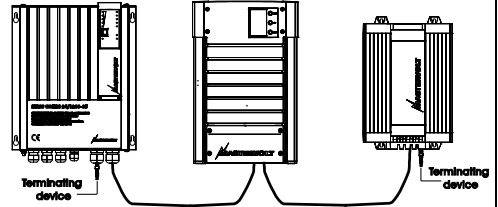

Do not make ring networks.

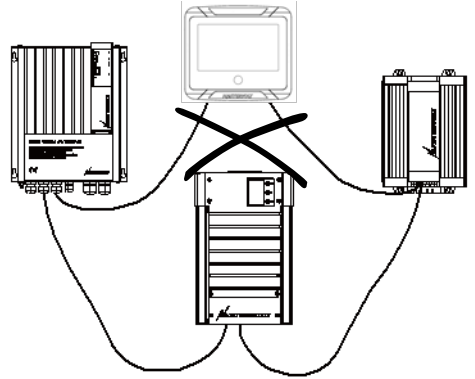

Do not make T-connections in the network.

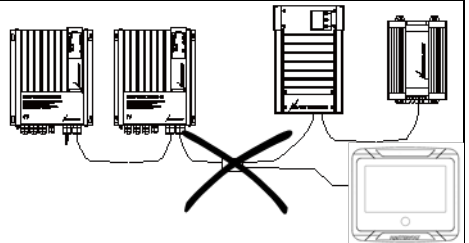

4 Installation instructions

The EasyView 5 offers three mounting options:

- **Panel mounting** onto the wall box - see section 4.1
- **Flush mounting** in an 82 x 113 mm hole - see separate instruction sheet with saw template
- **Clamp mounting** in a hole > 82 x 113 mm - see section 4.2

4.1 Panel mounting

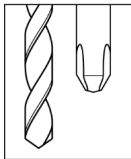

3mm PH2

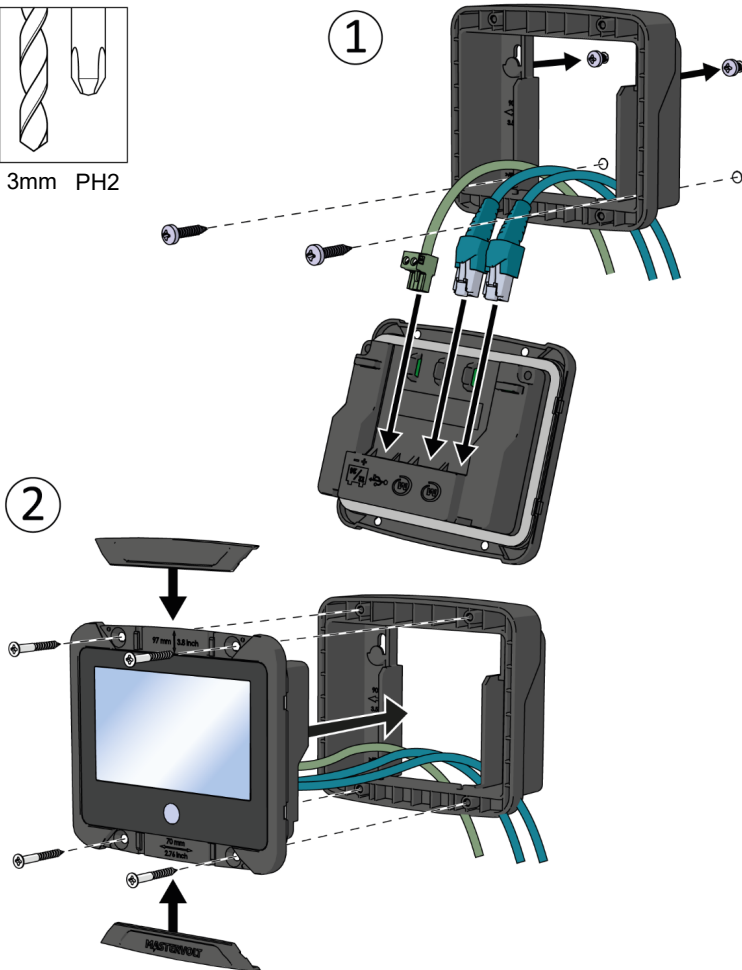

4.2 Clamp mounting

In case the mounting screws of the EasyView 5 have no grip, for instance when the EasyView 5 is installed as a refit and the dimensions of the mounting hole are too big, the wall box can also be used as a mounting clamp. Position the wall box at the back side of the installation panel, and use the supplied screws to fasten the display onto the wall box. The display will be clamped onto the panel. Depending on the thickness of the installation panel, use either the supplied 4x14mm or 4x30mm screws.

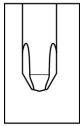

PH2

①

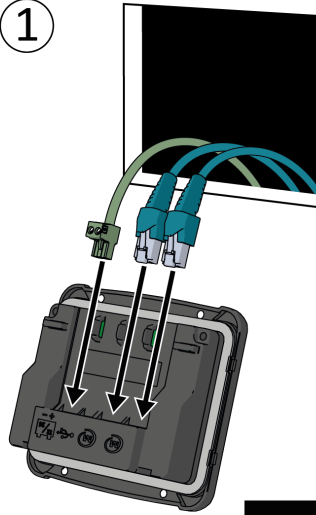

②

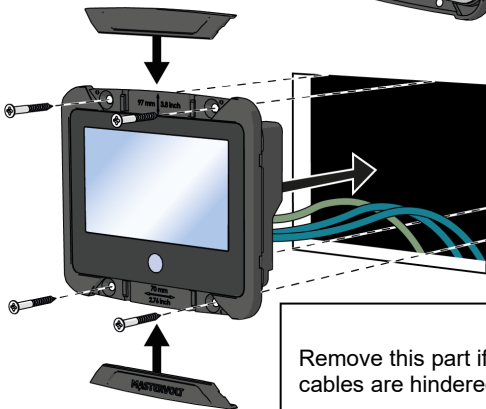

Remove this part if
cables are hindered

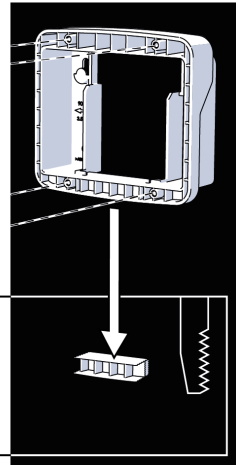

4.3 Aux power supply

The EasyView 5 can be powered from the MasterBus network. There must be MasterBus powering devices available to provide sufficient power to the network. If there is no MasterBus powering device or the available power is not sufficient, the EasyView 5 must be connected to a 12/24V battery via the supplied connector (see section 1.3).

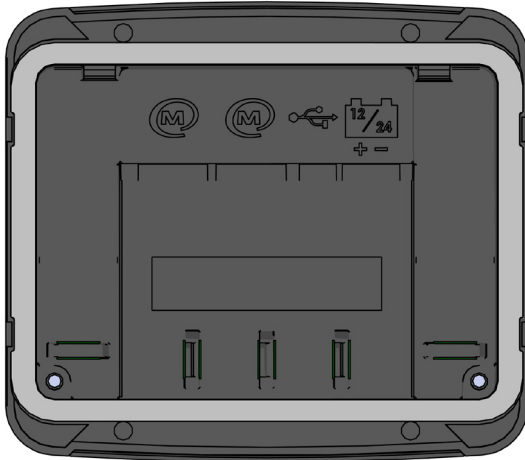

4.3.1 Aux power connector

Connect the positive wire to the left terminal, the negative wire to the right terminal of the connector.

Use a 3mm flat blade screw driver to tighten the screw of the connector.

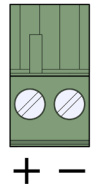

4.3.2 Wire size

Use appropriate wire size to connect the aux power supply to the battery.

Wire diameter Ø	
Min.	1 mm (18AWG)
Max.	2.5 mm (13AWG)

4.3.3 Fuse

Insert a 1A fuse in the positive battery line.



CAUTION!

Insert a 1A fuse in the positive battery line.



CAUTION!

Be sure to connect the battery to the EasyView 5 correctly! It is not protected against reverse polarity!

5 Operation

5.1 General

The Mastervolt EasyView 5 is a central monitoring and control panel for devices that are connected to the MasterBus network. It shows status information of your electrical system by means of a touch screen.

5.2 Home Button

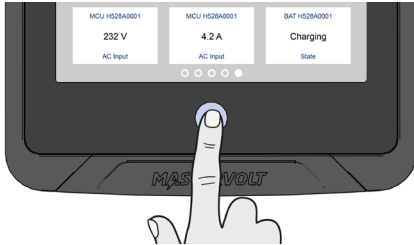

5.2.1 Switching on, off or standby

To switch on the EasyView 5: tap the Home button. After a short time, the first screen is shown for device selection, this screen is called the Dashboard.

To switch off: long-press (i.e. press and hold the button for about 3 seconds) the Home button and tap the Off option in the menu that appears.

To switch to standby mode: long-press the Home button and tap the Standby option.

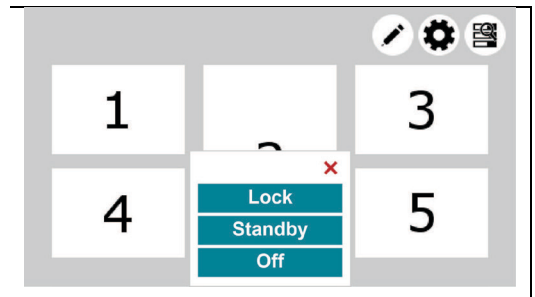

5.2.2 Locking

To lock the EasyView 5 when it is switched on, long-press the Home button and tap the Lock option. In this mode the panel will not react on tapping the screen. The “locked” symbol is shown in the upper left corner.

To unlock the EasyView 5, long-press (i.e. press and hold the button for about 3 seconds) the Home button.

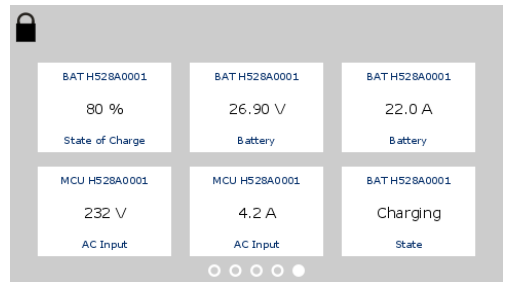

5.2.3 Home

Tapping the button when the EasyView 5 is switched on, returns you to the Home screen. The Home screen is the first favorite page on the Dashboard.

5.3 Dashboard and navigation

The dashboard consists of one or more favorite pages, showing an overview of user picked settings and values of connected devices on the MasterBus network. See section 6.1 for more details.

Navigate to another page by swiping or by tapping the left or right bottom of the screen. The bullets on the bottom of the dashboard show how many favorite pages there are, and which favorite page is currently being shown.



On the screen the following buttons can be shown:



Alarm button

Opens the list of active alerts. The button is only present when an alert is active.



Edit button

Opens the Edit page where you can add and edit widgets on the Dashboard. This button may be hidden. See section 6.6.



EasyView 5 settings button

Open the EasyView 5 Device page.



System button

Opens the System page, displaying a list of all connected devices.



USB button

Opens the USB update page. The button is only present when an USB flash drive is detected.



Add widget

Add widget(s) to the favorite page(s)



Back

Back one page



Confirm



Cancel/Remove

5.4 Maintenance

If you need to clean the touch screen without controlling functions, use the lock function as described in chapter 5.2.2. Clean touch screen with a soft cloth. Do NOT use acids or scourers!

6 Monitoring and configuration

6.1 Favorite pages

Favorite pages showing widgets containing system information or controls can be configured to be shown on the dashboard.

6.1.1 Adding widgets to favorite pages

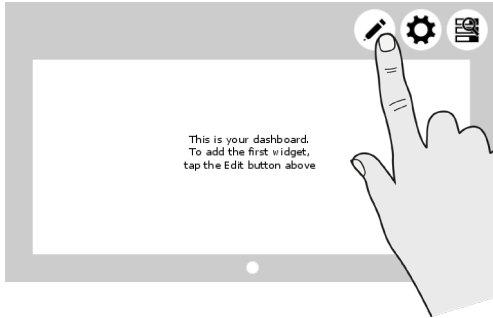

Tap the Edit button, to start configuring your favorite page(s). This button may be hidden. See section 6.6.

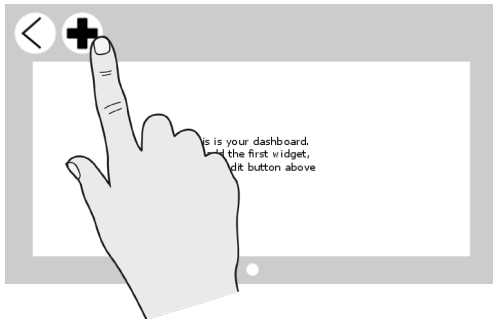

After tapping the Edit button, you enter the Edit page. To go back to the dashboard, tap the back arrow. Tap the plus button to add widget(s) to the favorite page.

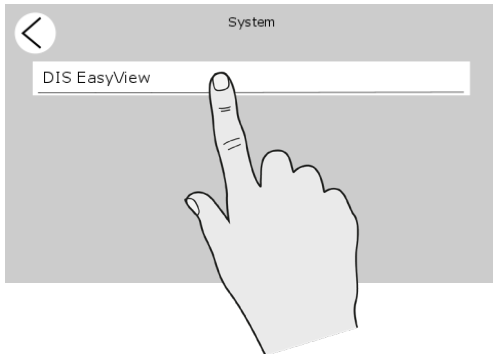

Select device in the System page. When no other devices are connected to the EasyView 5, only the EasyView 5 is shown in the System page.

The Device page of the EasyView 5 is shown as example in the following screenshots. Other devices have similar pages and widgets.

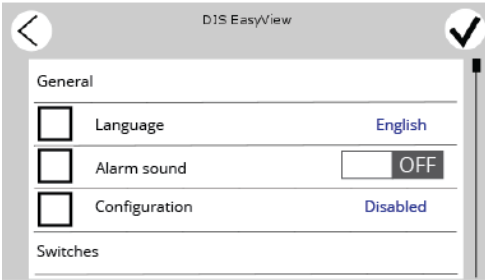

The Device page shows which items can be added on the favorite page.

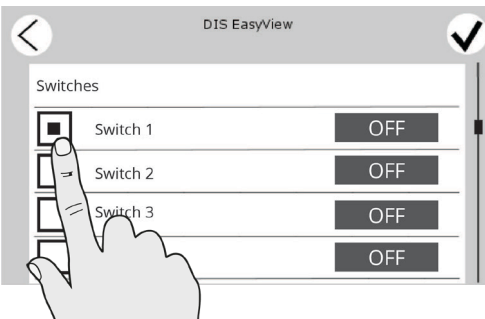

Select item(s) and tap the confirm button (✓) in the top right corner to confirm the selection.

Up to 6 items can be selected per favorite page. When 6 items are selected, selection of more items is automatically blocked. In total 6 favorite pages can be configured.

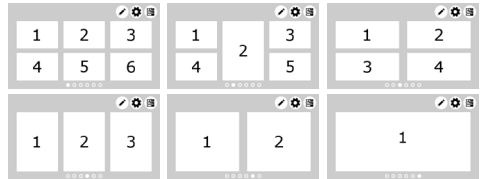

Upon return to the Edit page, the selected items appear as widgets.

An empty bullet is shown at the bottom of the Edit page. Navigate to this page by either swiping to the right or tapping the area right of the empty bullet, to create a new empty favorite page.



When the favorite page(s) are configured, tap the back arrow and you will return to the dashboard, now showing the favorite page(s) with widget(s).

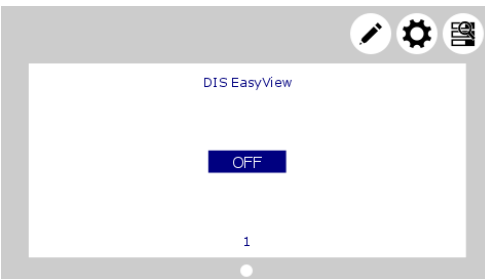

6.1.2 Widget order / move a widget

The order in which the widgets are selected, is also the order in which they appear on the favorite page. To change the order:

1. From the required favorites page, tap the edit button (✎). This button may be hidden. See section 6.6.
2. Long-press the widget you want to move. Arrow buttons will appear.
3. Move the widget to the required position by tapping the arrow button(s).
4. When finished, first tap the red cross in the top right corner, then tap the left arrow button in the top left corner.

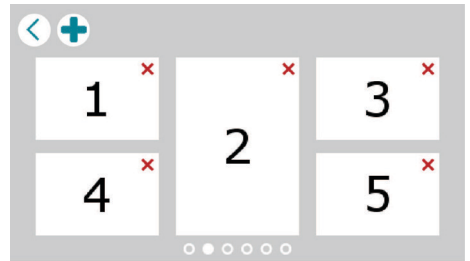
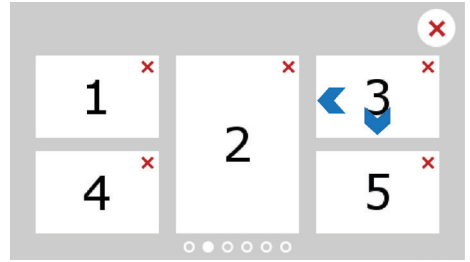

6.1.3 Removing a widget

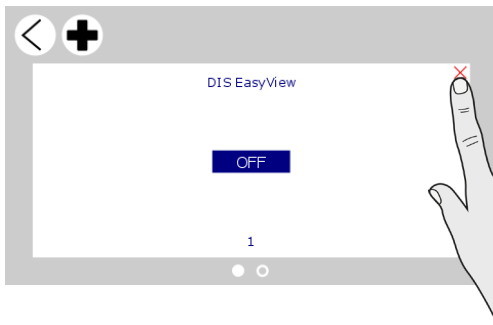
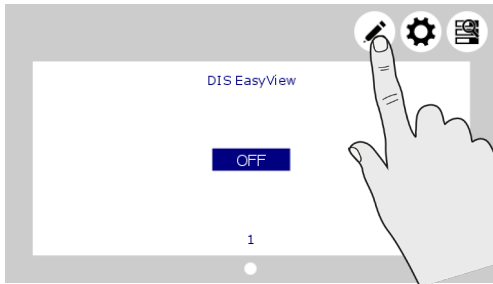

To remove a widget from a favorite page; tap the Edit button to go to the Edit page. This button may be hidden. See section 6.6.

Tap the red cross shown in the right upper corner of the widget to remove it.

6.1.4 Renaming a widget

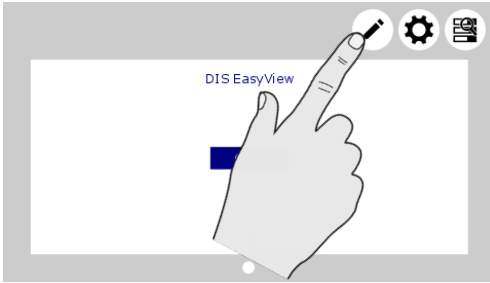

Tap the Edit button to go to the Edit page. This button may be hidden. See section 6.6.

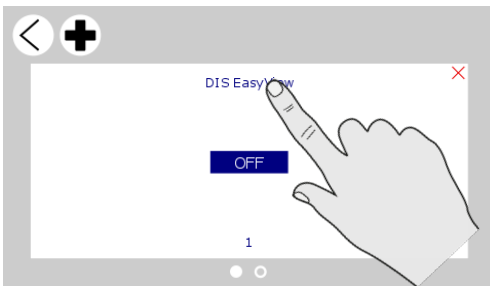

Tap the widget name to open the Custom name page.

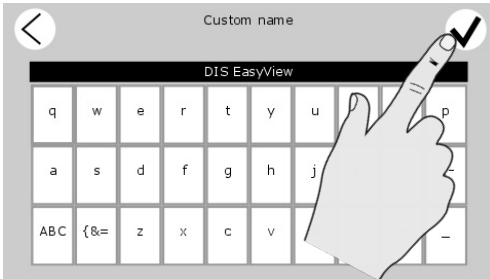

Make the required change and tap the confirm button.

Note: the customized name will not appear in MasterAdjust or show up in the system configuration data (xml)

6.2 System page



Tap the system browsing button to navigate to the System page.

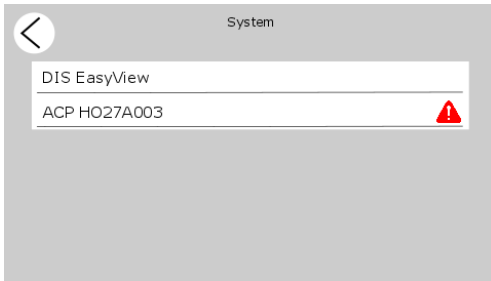

The System screen displays a list of all connected devices in alphabetical order. Select a device to navigate to its Device page. Devices from the list with an active alarm are accompanied by an alarm symbol.

6.3 Device page

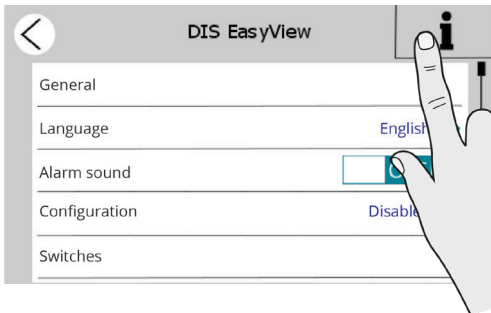

From the System screen (section 6.2), tap on a device to go to the Device page. Each device has its own Device page.

The Device page shows the current state of the selected device. The displayed values and switches depend on the device.

Tap "i" for Device information.

To enable configuration, see section 6.6.

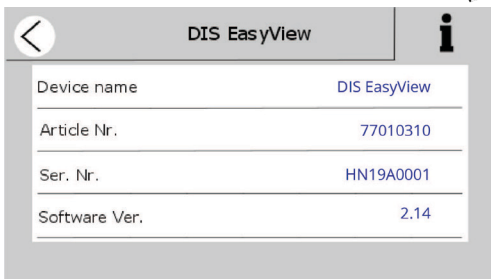

Device information

Shows a summary of device information and history.

6.4 Alarms

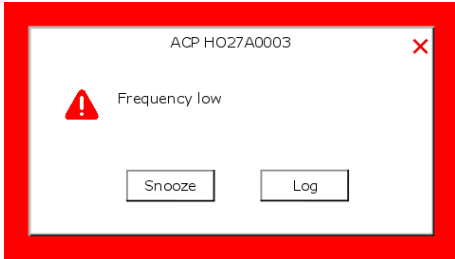

An Alarm popup is displayed when a connected device generates an alarm. Tap 'Log' to navigate directly to the device page or 'Snooze' to snooze the alarm. If the alarm persists, the popup is shown every 9 minutes.

The buzzer can also be target in MasterBus events. This means the buzzer can sound even if you switched it off in the configuration. See section 6.7.

You can also create your own alarm messages. These alarms have a yellow border. See section 6.11.

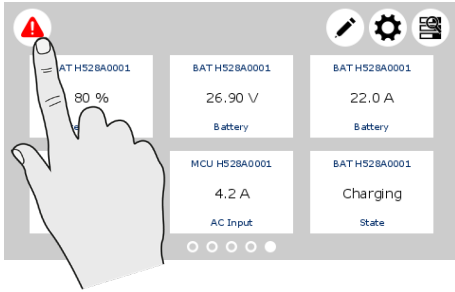

In case an alarm is present in the system, the Alarm button will be shown in the upper left corner of the Dashboard.

Tap the Alarm button from the Dashboard to open the list with active alerts from all connected devices.

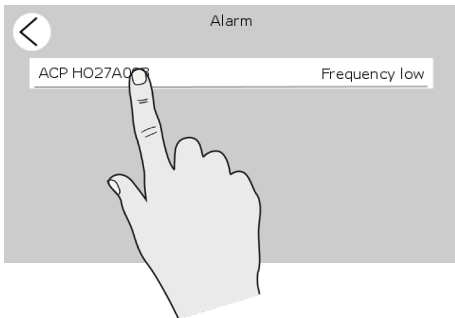

Tap the device you want to inspect.

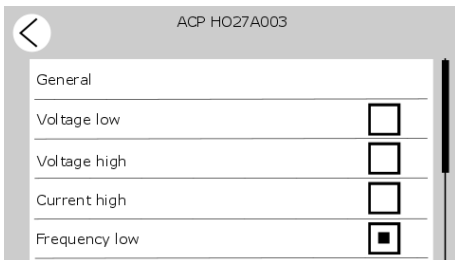

The alarm page of the selected device is shown. The selected box indicates the current alarm(s).

6.5 EasyView 5 monitoring settings

If you select the EasyView 5 from the System screen you will find the settings listed below. The settings are stored in the internal memory of the selected device. Therefore, switching off the EasyView 5 will not influence the settings.

Item	Meaning	Default	Range
General			
Language	Displayed language of the EasyView 5 This display enables changing the language of all connected MasterBus devices in one go.	English	See specifications
Alarm sound	Sound of the buzzer when an alarm is generated. When activated it repeatedly sounds for 10 seconds, 10 seconds off. The buzzer can also be target in the MasterBus events. See section 6.7. This means the buzzer can sound even if you switched it off in the configuration.	On	On, Off
Configuration	Enter Pin code to unlock the configuration menu.		
Switches			
Switch X	Configurable switch on the EasyView 5	-	X = 1 to 6
Power save			
Standby time	Time the display backlight stays illuminated since the last button was touched.	2 minutes	2, 5, 10 minutes, always on*
Auto off	Time after which the EasyView 5 will be switched off since the last button touch.	1 day	1 day, 2 days, always on
Backlight	Percentage of illuminance	50%	10-100%, in 10% steps
Widgets			
Page duration	Time each favorite page is shown, when slideshow of favorite pages is activated.	15 seconds	Off, 15, 20, 30, 40, 50, 60 seconds
Slide show	Slideshow of favorite pages	Off	On, Off

* You can still select the Standby option from the Home button menu (see section 5.2.1)

6.6 EasyView 5 configuration settings

To enable configuration:

1. Tap the settings button.
2. Tap Configuration, enter Pin code 1991 and tap the confirm button in the top right corner.
3. Go to the configuration tab.

The EasyView 5 configuration menu is used for read out and adjustment of settings.

Item	Meaning	Default	Range
General			
System name	Name of the system the EasyView 5 is installed on.	System name	Maximum 16 characters
Device name	Name of this device. This name will be recognized by all connected devices.	DIS EasyView 5	DIS+Maximum 12 characters
Switch X	Switches to use for event configuration. Renaming the switches after their application is recommended. X ranges 1 – 6.	Switch X	Maximum 16 characters
Devices in list	Devices to show in the device list. At <i>Selection</i> five selection boxes appear to choose a MasterBus device connected. <i>Excluded</i> means, you can select all devices except a maximum of five excluded devices.		Selection, All, Excluded
Auto Lock after	Time after which to lock the panel.	Off	Off, 2, 5, 10 minutes
Alarm	To only show alarms of selected devices, select <i>selection</i> .	All	All, selection
Show edit b.	<input checked="" type="checkbox"/> Show the Edit widgets button. <input type="checkbox"/> Hide the Edit widgets button. You may want to hide this button to prevent accidental removal of widgets.	Shown	Shown / hidden
Message			
Message X	Title of custom alarm message. X ranges 1 – 6. See section 6.11.		Maximum 16 characters
Message text X	Additional line(s) for alarm message X.		Maximum 16 characters
Events			
Event X Source			
Event X Target			
Event X Command		See section 6.7.	
Event X Data			

6.7 EasyView 5 events

Shown are the events to configure on the EasyView 5. The EasyView 5 can be both configured as an *event source* and an *event target*.

6.7.1 Event source

The EasyView 5 can be configured as an *event source*; an event source can be used to initiate an *event command* and an *event action by another device* that is connected to the MasterBus.

An example of an event where the EasyView 5 is the event source can be that a light can be switched Off when the EasyView 5 is switched On, the event source is then State.

Item	Meaning	Default	Range
Event X Source	Choose an event to serve as Event X Disabled means no event has been configured. The EasyView 5 features 6 Switches to serve as event sources. These switches can be named after their application.	Disabled	Disabled, Switch 1 - 6, State
Event X Target	Selection of the MasterBus connected device to take action due to Event X	Choose...	System dependent
Event X Command	<i>Event-based command</i> Action to be taken by the Event X target.	Choose...	System dependent
Event X Data	Event 1 data controls the Event X command, see section 6.8 for explanation.	Off	Off, On, Copy, Copy Invert, Toggle

6.7.2 Event target

The EasyView 5 can be configured as an *event target by other devices* on the MasterBus network. When the display is configured as an *event target* by another device, this device can initiate an *event command* and an *event action* to be performed by the EasyView 5.

An example might be that the buzzer of the EasyView 5 is switched on when there is a battery pre-low warning by an MLI battery. The event source is battery pre-low, the event target is the EasyView 5, the event command is Buzzer and event data Copy.

Item	Meaning	Default	Range
Event X Source	Choose an event to serve as Event X Disabled means no event has been configured.	Choose...	System dependent
Event X Target	Selection of the MasterBus connected device (in this case the EasyView 5) to take action due to Event X	Choose...	System dependent

Event X Command	<i>Event-based command</i> Action to be taken by the Event X target. The "Power save" command can be used to set the EasyView 5 in standby mode.	Disabled	Disabled, State, Lock, Feedback 1-6, Buzzer, Power save, Message 1-6
Event X Data	Event 1 data controls the Event X command, see section 6.8 for explanation.	Off	Off, On, Copy, Copy Invert, Toggle

6.8 Event data

The figure on the right shows an example of Input (pulses) and Output (data) to explain the Event Data.

On changes the status to On at the first signal.

Off changes the status to Off at the first signal.

Copy lets the status follow the input.

Copy Invert lets the status follow the opposite of the input. Copy is used for dimming too by holding the pulse switch pressed for a longer time.

Toggle changes the status at the first signal and back at the second signal. It is used in combination with a pulse switch.

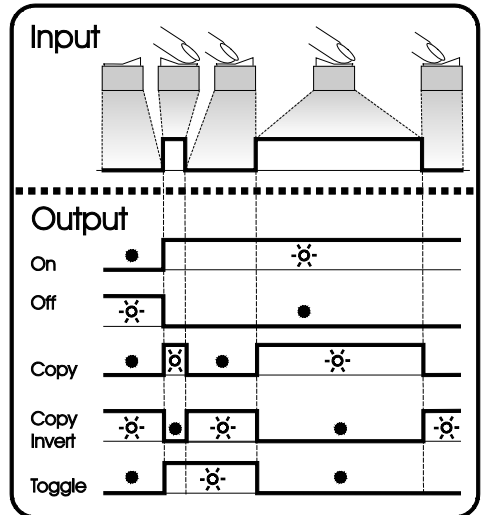

Event Data

6.9 Configuring other devices

Monitoring and configuring other devices is possible by selecting a device in the EasyView 5 device list, see section 6.2. Refer to the user manual of the connected device for an overview of all available settings. Settings are stored in the memory of the selected device. This means that switching off or disconnecting of the EasyView 5 will not affect the settings of the connected devices. See section 6.6 to enable configuration of all connected devices.

6.10 Digital switches

The EasyView 5 features 6 digital switches. Their function is based on event configuration of other devices. The switches, named Switch 1 to 6, can be renamed after their application.

The switches can be configured to show feedback information from the device that is being controlled by the configured event. In this other device, the feedback event needs to be configured to show feedback on the EasyView 5. See section 6.7.

6.11 Customize alarm messages

If you wish to create your own alarm messages:

1. Tap the EasyView 5 settings button.
2. If not enabled already, enable configuration (tap Configuration, enter Pin code 1991 and tap the confirmation button).
3. Go to the configuration tab.
4. Scroll to Messages

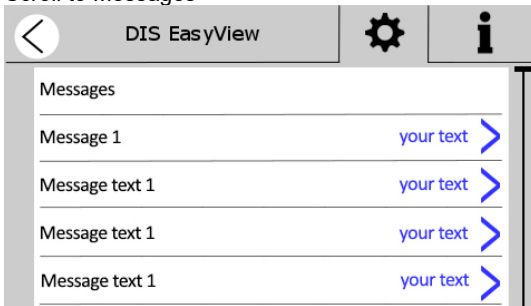

5. Tap one of the right arrows to open the keyboard, enter your text and tap the confirmation button in the top right corner.
6. When all required text lines are entered, tap the left arrow button, in the top left corner of the screen, twice to go to the System page.
7. Tap the device that can initiate the alarm.
8. Go to the configuration tab and scroll to Events.
How to setup the event depends on the device but the target should be the EasyView 5 and the command should be the customized message.
9. Tap the Home button to return to the Home screen.

6.12 Customize the startup screen

If you wish to use a custom image, such as a company logo, as the startup screen:

1. Name the file "startup.bmp".
Note: only images in bmp format (24-bit Bitmap) that are 480 × 272 pixels can be used.
2. Copy the file to the root folder of an USB flash drive.
3. Insert the USB flash drive in the USB port at the back of the EasyView 5.
4. Restart the EasyView 5.
5. Tap the USB flash drive button that appears on the dashboard and select "Set startup image" to upload the image.

The new startup screen is now setup and visible after restarting the display.

7 Updates

Software updates can be uploaded to the EasyView 5 by either MasterAdjust software or by USB flash drive. Other devices which are connected to the MasterBus network can only be updated using MasterAdjust software (see chapter 8).

To upload firmware to the EasyView 5 by USB, insert a USB flash drive in the USB port at the back of the device. After inserting the USB flash drive, restart the display (see 5.2.1). The USB flash drive is now detected, and a USB flash drive button appears on the dashboard.

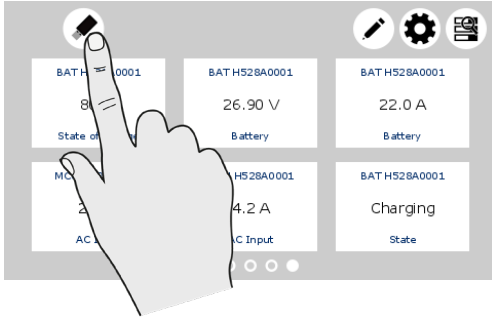

After the EasyView 5 has been switched off and on, the USB button is being shown in the left upper corner of the screen.

Tap the USB button to go to the USB page.



During the loading of the firmware the button 'Update software from USB' is grey.



Once the firmware is ready to be installed, the button changes color to white. Now tap the button and the display will show bootloading. This will take approximately 30-60 seconds*, depending on the size of the update. After the upgrade the display will switch on automatically.



Do not disconnect or switch off the EasyView 5 while updating!

* Updating via MasterAdjust takes approximately 15 minutes.

8 MasterAdjust software

For system configuration settings, you need the MasterAdjust software. To use MasterAdjust, you need a MasterBus-USB interface for communication between your PC and the MasterBus. See the user manual of the MasterBus-USB interface for detailed information.

Mastervolt MasterAdjust software is available as free to download software on the Mastervolt website (www.mastervolt.com). Features:

- Update software;
- System configuration: to adjust the entire MasterBus network and all connected devices in accordance with your personal preferences, including programming of *Event-based commands* (see section 6.7);
- System Monitor: complete actual overview of your entire electrical installation;
- System logger: data logging instrument to retrieve historical data of your electrical installation.

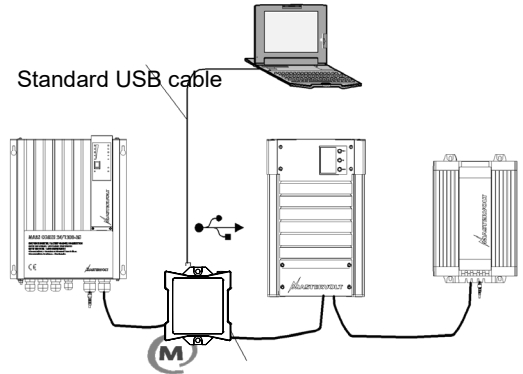

Masterbus – USB interface

9 Trouble shooting

Contact your local Mastervolt Service Centre if you cannot correct a problem with the aid of the trouble shoot table below. See www.mastervolt.com for an extended list of Mastervolt Service Centers.

Failure	Possible cause	What to do
No display function.	Display is switched off.	Tap the Home button.
	Error in the wiring.	Check the MasterBus cables.
	In case the EasyView 5 is connected only to MasterBus, no powering device available.	The EasyView 5 can be powered by the network. This means that at least one device in the network should have powering capabilities (see section 3.3). Connect the aux supply of the EasyView 5, section 4.3.
Display shows ALARM.	A MasterBus device connected indicates an alarm situation.	Check the alarm source shown on the display and press LOG to stop the alarm or SNOOZE to let the alarm repeat every 9 minutes.

Failure	Possible cause	What to do
Backlight suddenly changes color from white to red.	An alarm situation triggers the backlight to turn red. See also section 6.4.	Check the alarm source shown on the display and press LOG to stop the alarm or SNOOZE to let the alarm repeat every 9 minutes.
Back light does not switch on after touching the screen.	Back light has been set to switch off.	Check EasyView 5 Configuration. See section 6.5
No backlight.	Backlight switches off after default 2 minutes.	Tap on the screen or Home button or refer to section 6.5 to adjust the settings of the backlight.
Slow or no communication.	Error in the MasterBus wiring.	Check the MasterBus cables.
	No terminating device placed at the ends of the network.	MasterBus needs a terminating device on both ends of the network. Check if connected (see section 3.3).
	MasterBus network is configured as a ring network.	Ring networks are not allowed. Check the connections of the network (see section 3.3).
	T-connections in the MasterBus network.	Check if T-connections are made in the network. T-connections are not allowed (see section 3.3).
Touch screen does not react.	Lock has been activated.	Long-press Home button to unlock panel, see section 5.2.
	Screen is frozen.	To force a restart, press and hold the Home button until the display switches off and on again. This may take about 20 seconds.
Functions are controlled without intention while touch screen is cleaned.	A touch screen reacts at every touch.	Long-press Home button to lock panel, see section 5.2. Clean touch screen with a soft cloth. Do NOT use acids or scourers! Long-press Home button again to unlock.
One of the connected devices cannot be found.	Settings error: maximum number of devices is 63.	If you want to monitor more than 63 devices, you need to have a second EasyView 5 panel.

Failure	Possible cause	What to do
	The display is in "Selection" mode with another device selected.	Change the setting to "All devices".
	Error in the wiring.	Check the MasterBus cables.
	Device not suitable for MasterBus or it is excluded in the "Excluded" mode.	Check whether the device is suitable for MasterBus. Maybe the MasterBus cable is connected to a non-MasterBus connector.
The EasyView 5 is switched off after some time.	The EasyView 5 is set up to switch off automatically, when no button is touched for 1 day.	See section 6.5 for settings (Auto off).
The device name is not correct.	Device name has not yet been set.	Adjust device name, see section 6.6.
Wrong language is displayed.	Wrong setting of the language at the EasyView 5.	See section 6.5 for adjustment of the language.
	Wrong setting of the language at one of the connected devices.	Each separate connected device can have its own language setting. See user manual of the connected devices.
Wrong system name is displayed.	Wrong setting of the system name at the EasyView 5.	See section 6.6 for setting "Name system".
You don't have the slightest idea where in the menu structure you have ended up.	You just discovered some unexpected screens.	Tap the Home button, this always takes you back to the home screen
Widget shows Device offline	A device is not communicating or has been removed from the MasterBus network.	Check the connections of the network (see section 3.3).
		If the device has been removed from the network, go to edit mode and remove the widget.

10 Specifications

10.1 Technical specifications

	EasyView 5
Product code	77010310
Weight	0.36kg 0.79lbs
Dimensions	113 x 127 x 43 mm 4.4 x 5.0 x 1.7 inch
Display size	109 mm 4.3 inch
Display languages	EN/NL/DE/ES/IT/FR/FI/SV/NO/DA/RU
IP degree	IP67 front, IP23 back
Power supply	MasterBus / 12V/24V input
Power consumption	Sleep mode ~ 0.9W, Normal mode ~ 1.6W

10.2 Dimensions

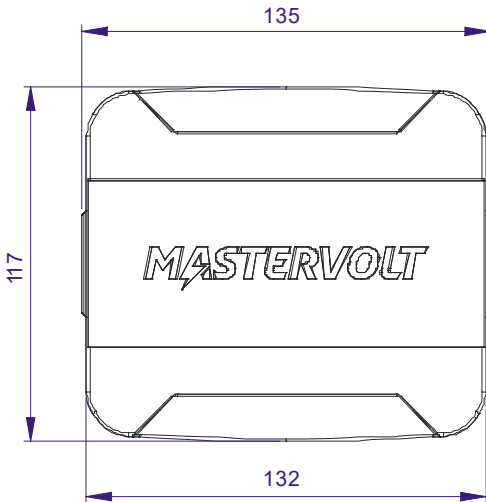

Front cover

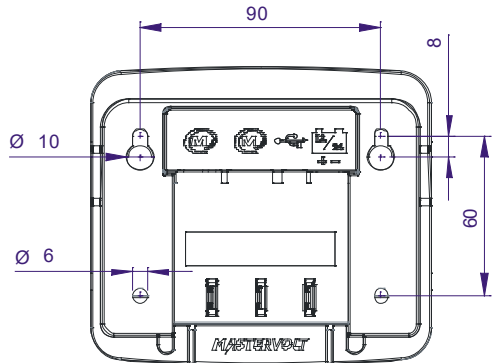

Back, with wall box

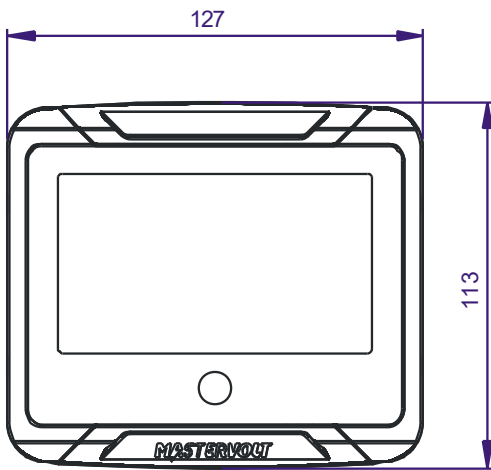
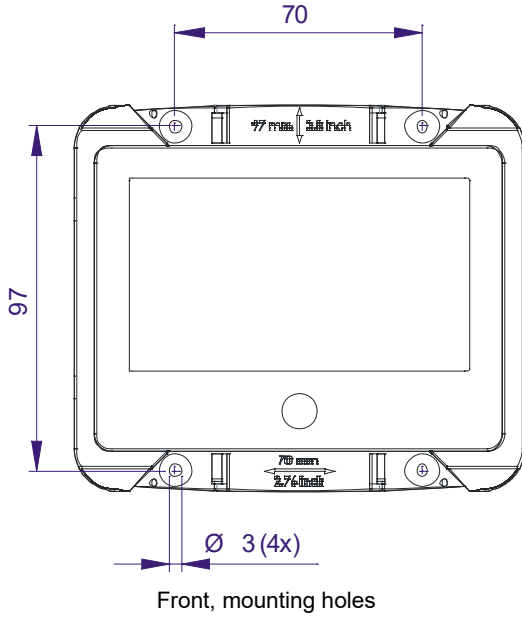

Front

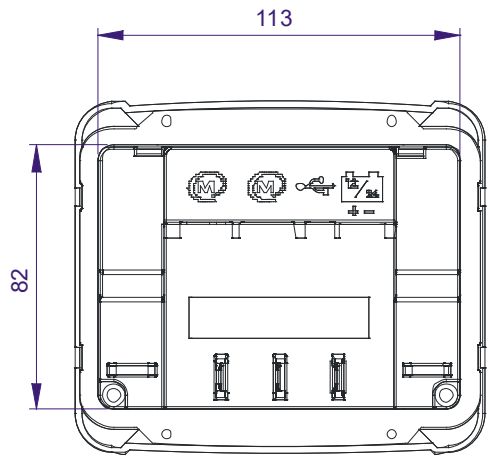

Back, without wall box

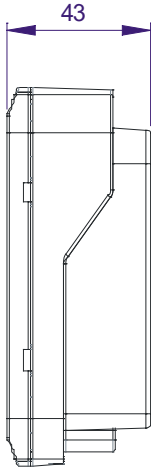

Side, with wall box

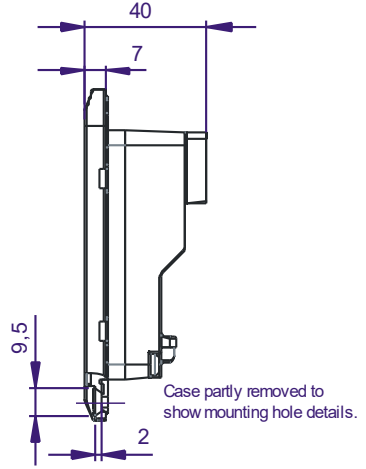

Side, without wall box



Europe, Middle East & Africa

Customer Service

T: +31 (0) 20 34 22 100

E: info@mastervolt.com

Technical Support

T: +31 (0) 20 34 22 100

E: ts@mastervolt.com

Location & Shipping

Mastervolt

Snijdersbergweg 93

1105 AN Amsterdam

The Netherlands

Americas & Caribbean

Customer Service

T: +1 800 307 6702, Option 1

E: orderentry@marinco.com

Technical Support

T: +1 800 307 6702, Option 2

E: tsusa@mastervolt.com

Location & Shipping

Power Products, LLC

N85 W12545 Westbrook Crossing

Menomonee Falls, Wisconsin 53051

United States

Asia Pacific

Customer Service

T: +64 9 415 7261 Option 1

E: enquiries@bepmarine.com

Technical Support

T: +64 9 415 7261 Option 3

E: technical@bepmarine.com

Location & Shipping

BEP Marine

42 Apollo Drive

Rosedale, Auckland 0632

New Zealand